

PRODUCT CODE: AB22G-K
ADAPTABLE BOX - KNOCKOUT



DESCRIPTION

300 x 300 x 50mm (12 x 12 x 2") Adaptable Box with Knock-outs

FINISH

Pre Galvanised

MATERIAL

Galvanised Sheet Steel

PACKAGING

Packed in qty 2 (can be purchased individually)

ADDITIONAL NOTES

Comprises body, flanged cover and M5 x 10mm lid fixing screws
Knock outs - 7 x 20mm on each face
Compliant to LU Standard 1-085 (for use on surface & sub-surface locations)

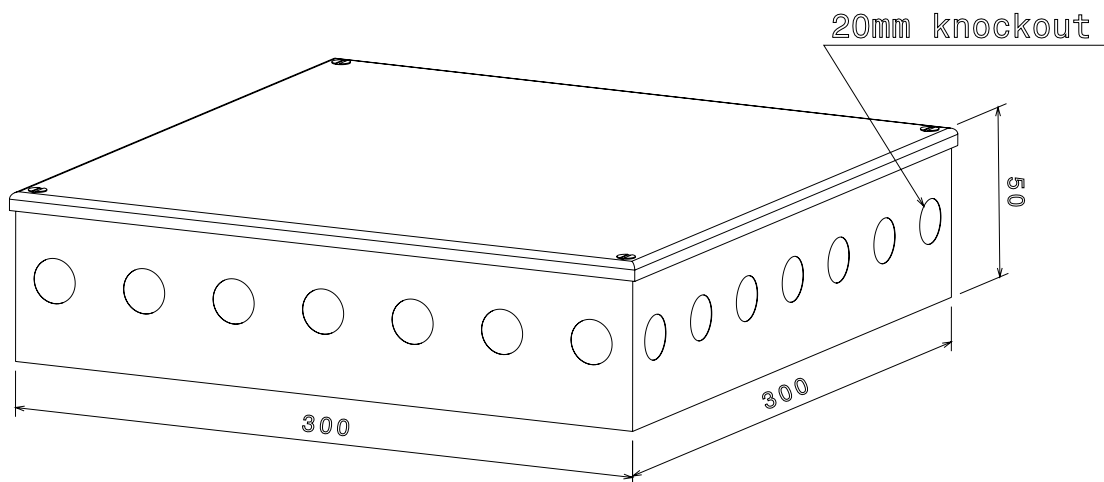

Isometric view

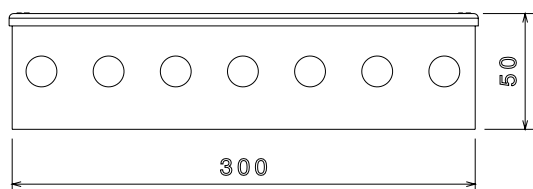

Front view

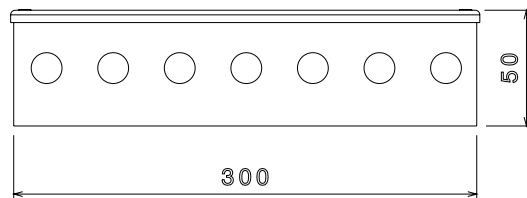

Side view